

2-Line, Uni-directional, Transient Voltage Suppressor

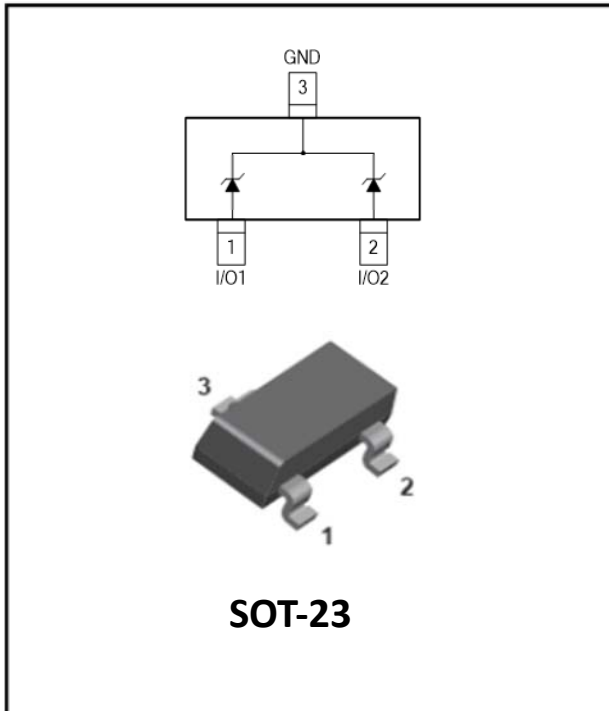

Features

- Stand-off voltage: 17V
- Transient protection for each line according to
IEC61000-4-2(ESD): $\pm 30\text{kV}$ (contact)
IEC61000-4-5(surge): 1.4A (10/1000 μs)
- Low leakage current:
- Ultra low clamping voltage
- RoHS Compliant

Applications

- Cellular Handsets and Accessories
- Notebooks and Handhelds
- Portable Instrumentation
- Set Top Box
- Industrial Controls
- Server and Desktop PC

Mechanical Data

- Package: SOT-23
- Lead Finish: Matte Tin
- Case Material: "Green" Molding Compound
- Moisture Sensitivity: Level 1 per J-STD-020
- Marking Information: See Below

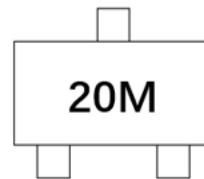

■Definitions of electrical characteristics

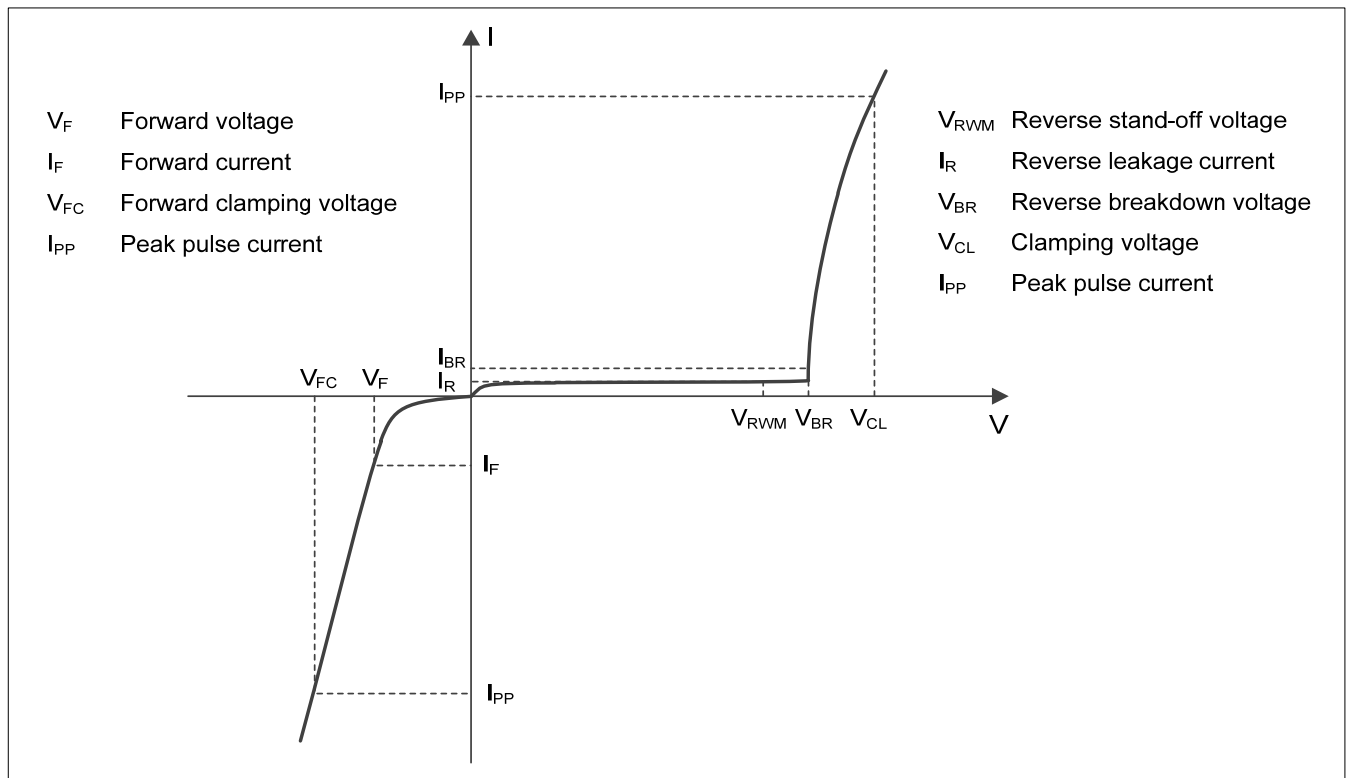



MMBZ20VC

■Maximum Ratings

PARAMETER	SYMBOL	LIMITS	UNIT
Peak pulse power ($t_p = 10/1000\mu s$)	P_{pk}	39.2	W
Peak pulse current ($t_p = 10/1000\mu s$)	I_{PP}	1.4	A
ESD according to IEC61000-4-2 air discharge	V_{ESD}	± 30	KV
ESD according to IEC61000-4-2 contact discharge		± 30	
Junction temperature	T_J	-55~150	$^{\circ}C$
Storage temperature	T_{STG}	-55~150	$^{\circ}C$

■Electrical Characteristics ($T_a=25^{\circ}C$ Unless otherwise specified)

PARAMETER	Symbol	UNIT	Conditions	Min	Typ	Max
Reverse maximum working voltage	V_{RWM}	V				17
Reverse leakage current	I_R	nA	$V_{RWM} = 17V$			50
Reverse breakdown voltage	V_{BR}	V	$I_{BR} = 1mA$	19.00		21.00
Clamping voltage ²⁾	V_{CL}	V	$I_{PP} = 1.4A, t_p = 10/1000\mu s$			28
Junction Capacitance	CJ	pF	$V_R=0V, f=1MHz$		77	

Notes:

- (1). TLP parameter: $Z_0 = 50\Omega$, $t_p = 100ns$, $t_r = 2ns$, averaging window from 60ns to 80ns. R_{DYN} is calculated from 4A to 16A.
- (2). Non-repetitive current pulse, according to IEC61000-4-5.

■Ordering Information (Example)

PREFERRED P/N	PACKING CODE	UNIT WEIGHT(mg)	MINIMUM PACKAGE(pcs)	INNER BOX QUANTITY(pcs)	OUTER CARTON QUANTITY(pcs)	DELIVERY MODE
MMBZ20VC	F2	Approximate 10	3000	30000	120000	7" reel



■ Characteristics (Typical)

Fig1: Pulse Waveform

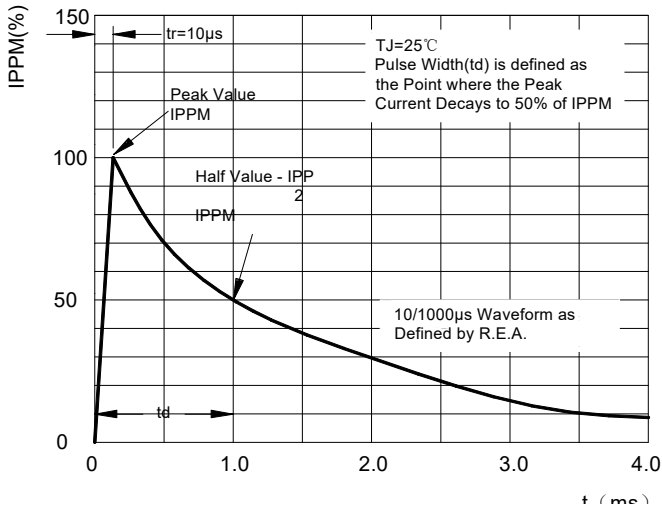

Fig 2: Contact discharge current waveform per IEC61000-4-2

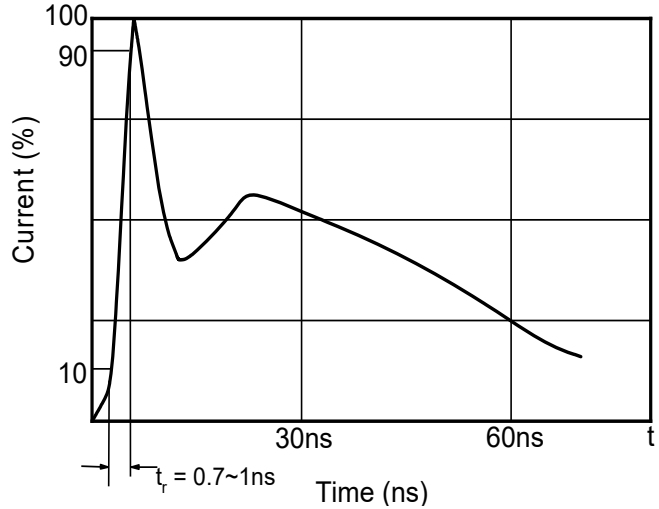

Fig3: Clamping voltage vs. Peak pulse current

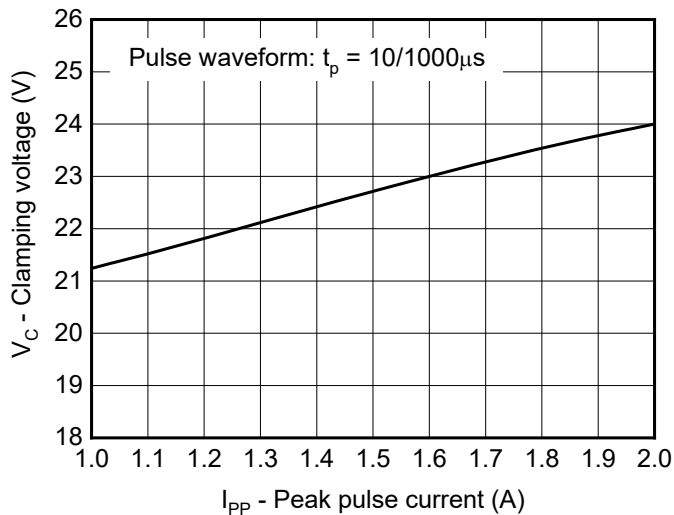

Fig4: Capacitance vs. Reverse voltage

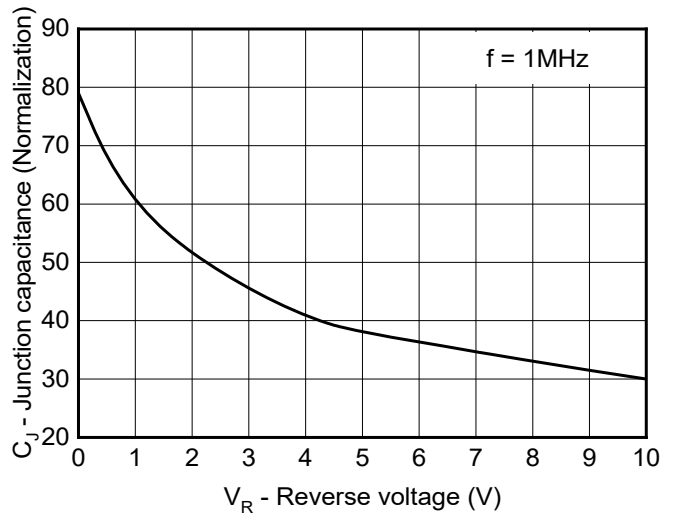

Fig5: Non-repetitive peak pulse power vs. Pulse time

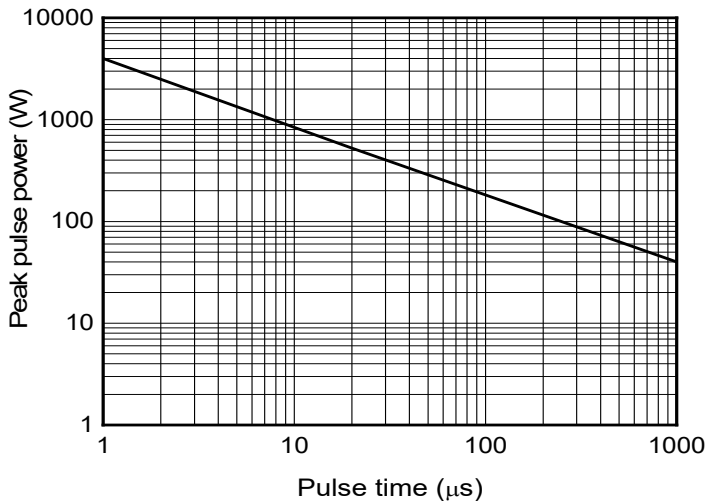
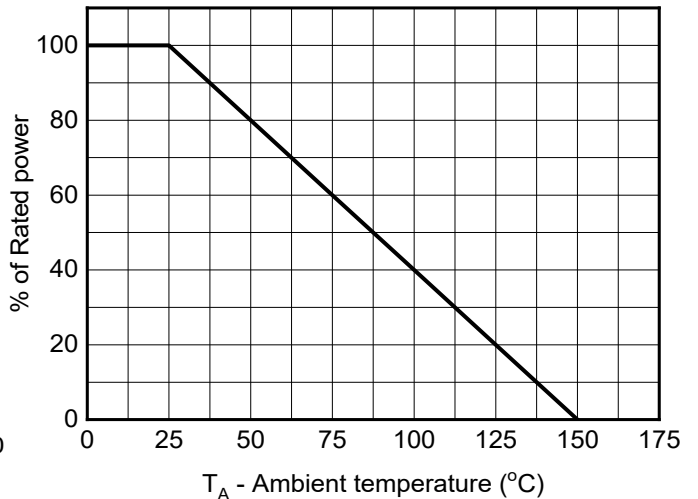

Fig6: Power derating vs. Ambient temperature





MMBZ20VC

■ Outline Dimensions

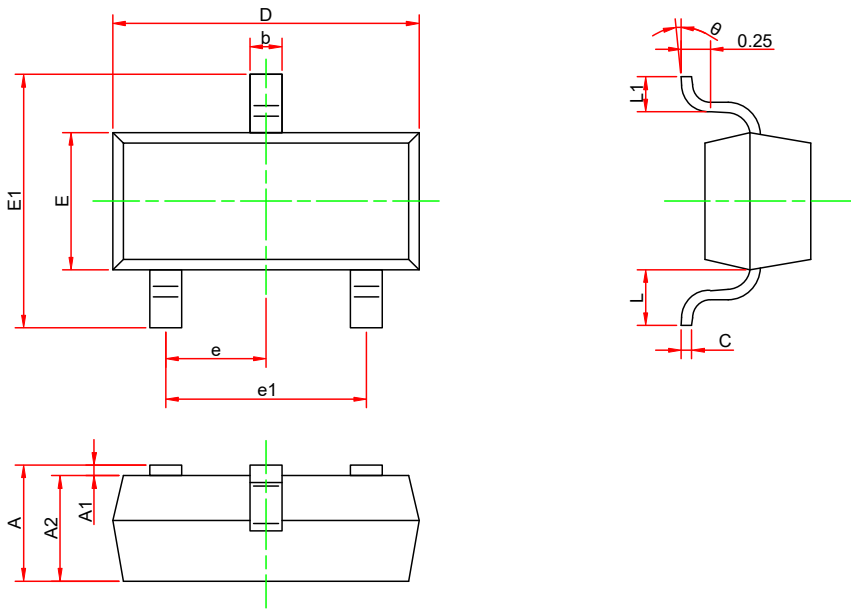

Symbol	Dimensions in millimeters		
	Min.	Typ.	Max.
A	0.900	-	1.150
A1	0.000	-	0.100
A2	0.900	-	1.050
b	0.300	-	0.500
c	0.100	-	0.200
D	2.800	-	3.000
E	1.200	-	1.400
E1	2.250	-	2.550
e	0.950TYP		
e1	1.800	-	2.000
L	0.550REF		
L1	0.300	-	0.500
θ	0°	-	8°

■ Soldering Footprint

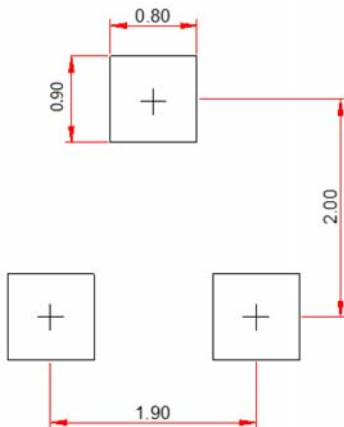

Notes:

This recommended land pattern is for reference purposes only. Please consult your manufacturing group to ensure your PCB design guidelines are met.



MMBZ20VC

Disclaimer

The information presented in this document is for reference only. Yangzhou Yangjie Electronic Technology Co., Ltd. reserves the right to make changes without notice for the specification of the products displayed herein to improve reliability, function or design or otherwise.

The product listed herein is designed to be used with ordinary electronic equipment or devices, and not designed to be used with equipment or devices which require high level of reliability and the malfunction of which would directly endanger human life (such as medical instruments, transportation equipment, aerospace machinery, nuclear-reactor controllers, fuel controllers and other safety devices), Yangjie or anyone on its behalf, assumes no responsibility or liability for any damages resulting from such improper use of sale.

This publication supersedes & replaces all information previously supplied. For additional information, please visit our website [http:// www.21yangjie.com](http://www.21yangjie.com) , or consult your nearest Yangjie's sales office for further assistance.